

2. Belt S. 12

Pitch 12,5 mm

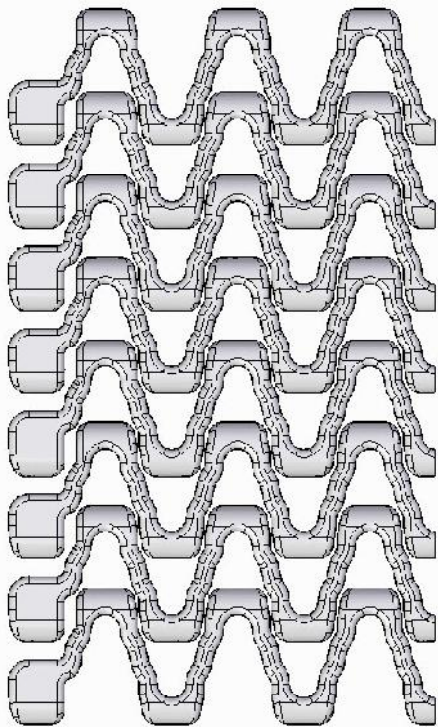

S. 12-401



Belt data		
Materials	Max. belt pull kg/m of width	Belt weight kg/m ²
Polyethylene (PE)	600	3,5
Polypropylene (PP)	800	3,5
Polyacetal (POM)	1450	4,8

Belt surface: Open belt with a smooth surface.
Open area: 40%. Biggest opening 6 x 8 mm.
Strength: Ideal choice for light transportation.
Material/colour: PE/nat, PP/white and grey. POM/blue
Cleanability: Excellent. FSIS
Accessories: 25 mm. Flight, friction top
Application: Cooling belt for small nose bar.
Standard widths: Increments of 20 mm, e.g. 100, 120 mm etc

Protected by the EU Design Registration

Sprocket Data								
No. of teeth	A= Outside diameter	B= Pitch diameter	C= Inside-diameter	Hub width:	Round bore		Square bore	
					mm	in.	mm	in.
10	50	42	33	8	20	3/4	25/40	1½
19	84	76	67	12	20/25/30/40		25/40	1½
24	104	96	87	12	20/25/30/40		25/40	1½
28	120	112	103	12	20/25/30/40		25/40	1½

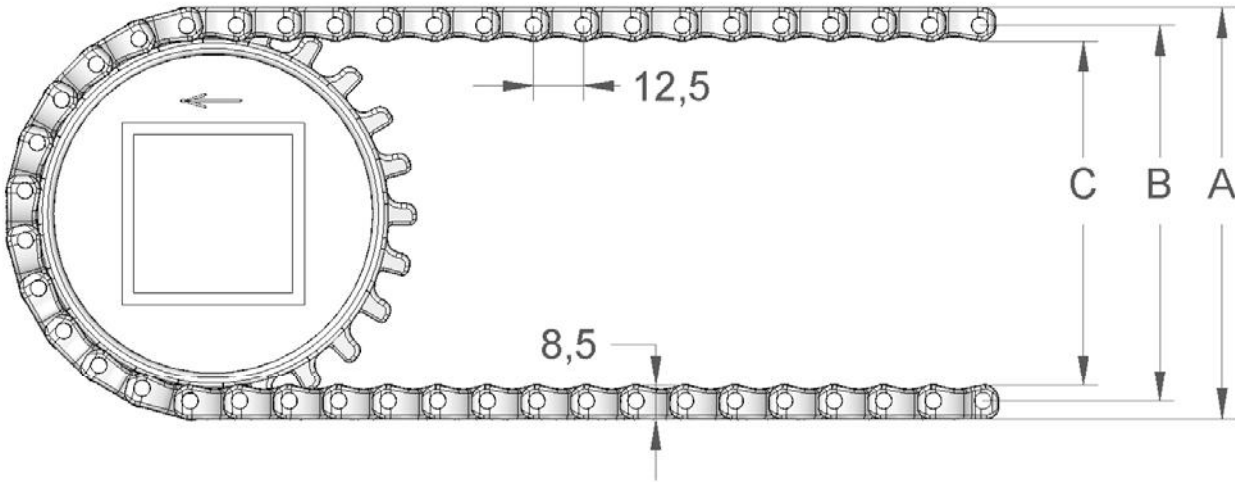

S. 12-406

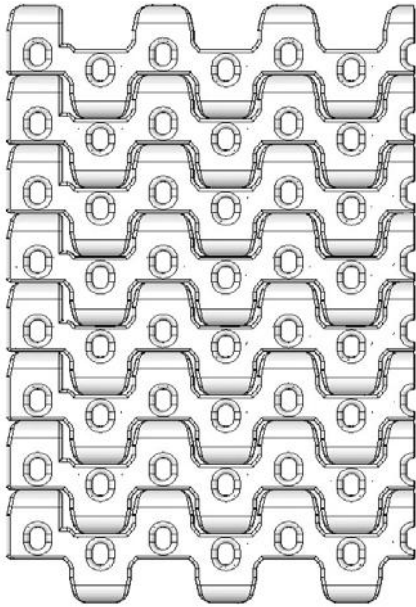

Belt data		
Materials	Max. belt pull kg/m width	Belt weight kg/m ²
Polyethylene (PE)	600	4,5
Polypropylene (PP)	800	4,5
Polyacetal (POM)	1450	6

Belt surface: Perforated flat top.
Open area: 8%. Biggest opening 4 x 2,5 mm.
Strength: Ideal choice for light transportation.
Material/colour: PE/nat, PP/white and grey. POM/blue
Cleanability: Excellent. FSIS
Accessories: 25 mm flights, friction top.
Application: Cooling belt for small nose bar (14 mm).
Standard widths: Increments of 20 mm, e.g. 100, 120 mm etc.

Protected by the EU Design Registration

Sprocket Data								
No. of teeth	A= Outside diameter	B= Pitch diameter	C= Inside-diameter	Hub width:	Round bore		Square bore	
					mm	in.	mm	in.
10	50	42	33	8	20	3/4		
19	84	76	67	12	20/25/30/40		25/40	1½
24	104	96	87	12	20/25/30/40		25/40	1½
28	120	112	103	12	20/25/30/40		25/40	1½

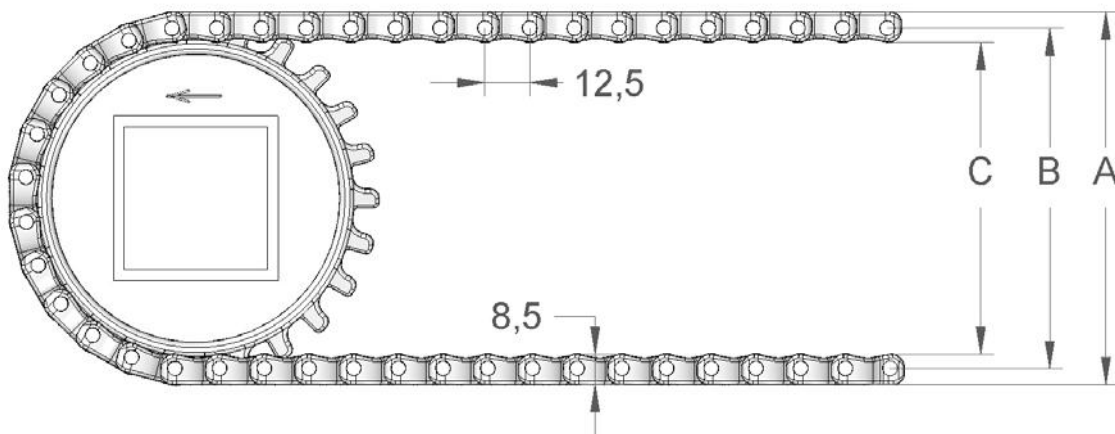

S. 12-408

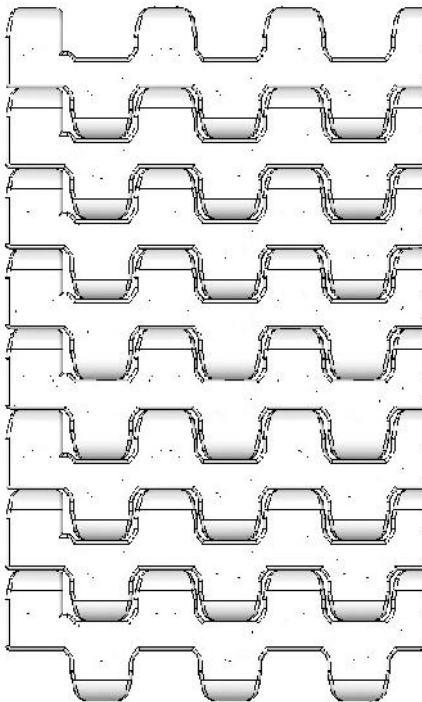

Belt data		
Materials	Max. belt pull kg/m of width	Belt weight kg/m ²
Polyethylene (PE)	600	4,5
Polypropylene (PP)	800	4,5
Polyacetal (POM)	1450	6

Belt surface: Flat top.
Open area: Closed.
Strength: Ideal choice for light transportation.
Material/colour: PE/nat, PP/white and grey. POM/blue
Cleanability: Excellent. FSIS
Accessories: 25 mm flights, friction top.
Application: Cooling belt for small nose bar (14 mm)
Standard widths: Increments of 20 mm, e.g. 100, 120 mm etc

Protected by the EU Design Registration

Sprocket Data								
No. of teeth	A= Outside diameter	B= Pitch diameter	C= Inside-diameter	Hub width:	Round bore		Square bore	
					mm	in.	mm	in.
10	50	42	33	8	20	3/4	25/40	1½
19	84	76	67	12	20/25/30/40		25/40	1½
24	104	96	87	12	20/25/30/40		25/40	1½
28	120	112	103	12	20/25/30/40		25/40	1½

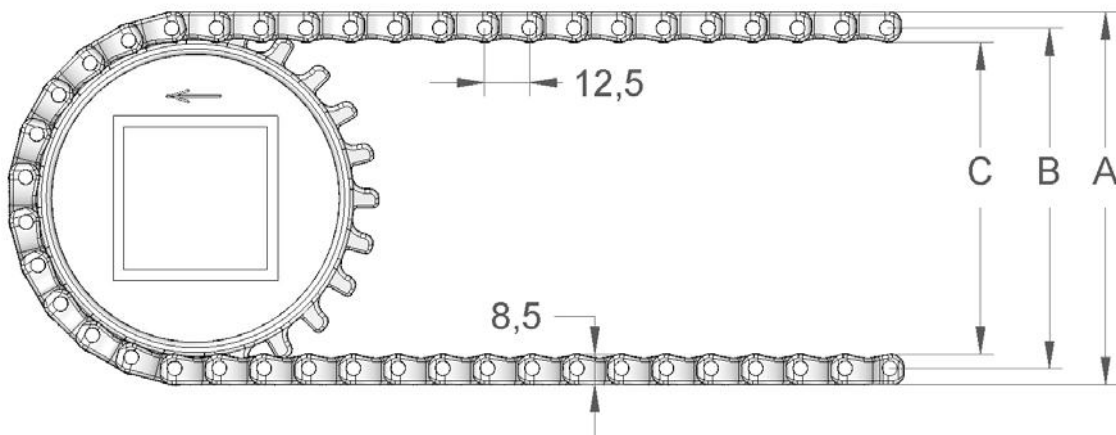

S. 12-408 F/2 component

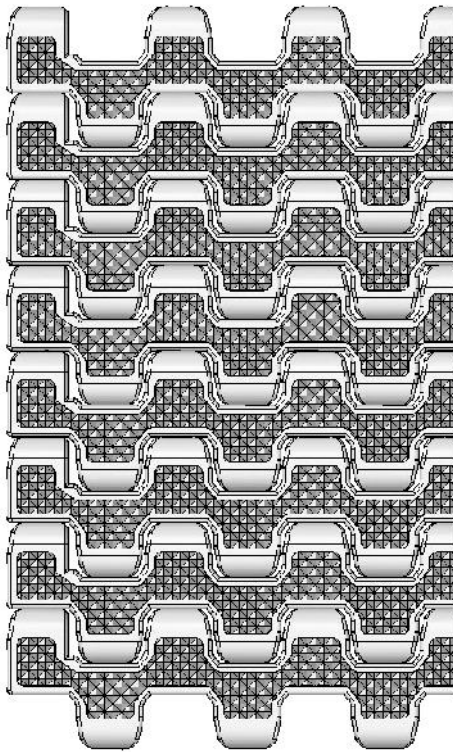

Belt data		
Materials	Max. belt pull kg/m of width	Belt weight kg/m ²
Copolymer:	750	6

Belt surface: Flat top with friction surface.
Open area: Closed.
Strength: Ideal choice for light transportation.
Colour: nat/white.
Cleanability: Excellent. FSIS
Accessories: 25 mm flights
Application: Transport of goods on a slightly inclined conveyor. Runs on 14 mm nose bar.
Standard widths: Increments of 20 mm, e.g. 100, 120 mm etc

Protected by the EU Design Registration

Sprocket Data								
No. of teeth	A= Outside diameter	B= Pitch diameter	C= Inside-diameter	Hub width:	Round bore		Square bore	
					mm	in.	mm	in.
10	52	42	33	8	20	3/4	25/40	1½
19	86	76	67	12	20/25/30/40		25/40	1½
24	106	96	87	12	20/25/30/40		25/40	1½
28	122	112	103	12	20/25/30/40		25/40	1½

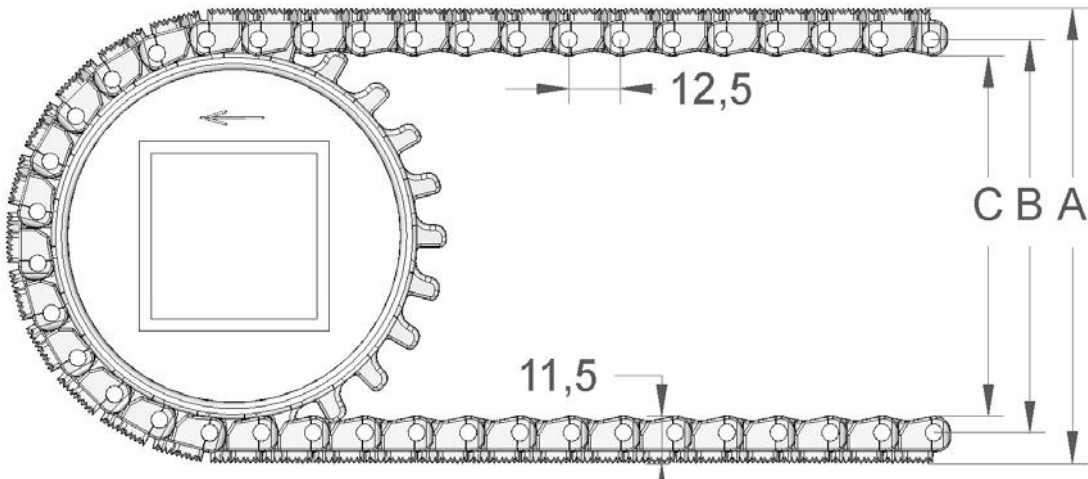

S. 12-438

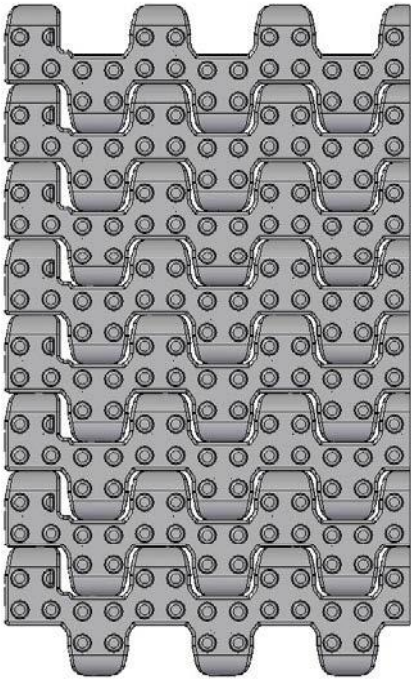

Belt data		
Materials	Max. belt pull kg/m of width	Belt weight kg/m ²
Polyethylene (PE)	600	4,5
Polypropylene (PP)	800	4,5
Polyacetal (POM)	1450	6

Belt surface: Structure top with 2 mm nubs.
Open area: Closed.
Strength: Ideal choice for light transportation.
Material/colour: PE/nat, PP/white and grey. POM/blue
Cleanability: Excellent. FSIS
Accessories: 25 mm flights, friction top.
Application: Ideal for poultry, meat and seafood industry.
 Cooling belt for small (14 mm) nose bar.
Standard widths: Increments of 20 mm, e.g. 100, 120 mm etc.

Protected by the EU Design Registration

Sprocket Data								
No. of teeth	A= Outside diameter	B= Pitch diameter	C= Inside-diameter	Hub width:	Round bore		Square bore	
					mm	in.	mm	in.
10	53	42	33	8	20	3/4	25/40	1½
19	87	76	67	12	20/25/30/40		25/40	1½
24	107	96	87	12	20/25/30/40		25/40	1½
28	123	112	103	12	20/25/30/40		25/40	1½

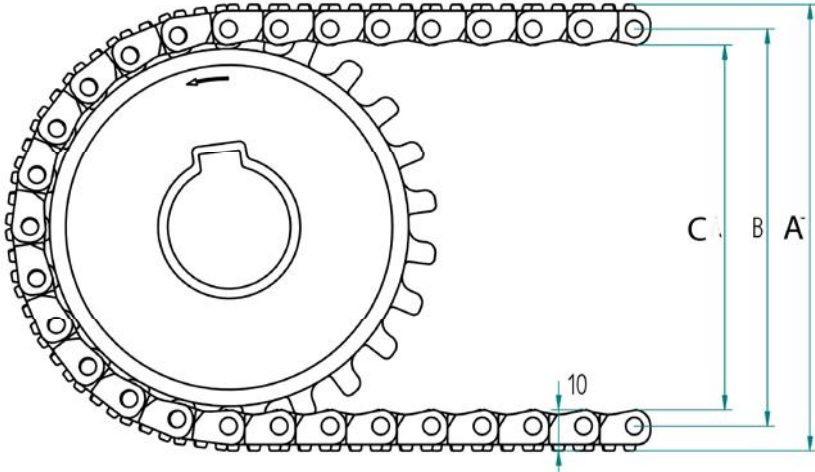

S. 12-448

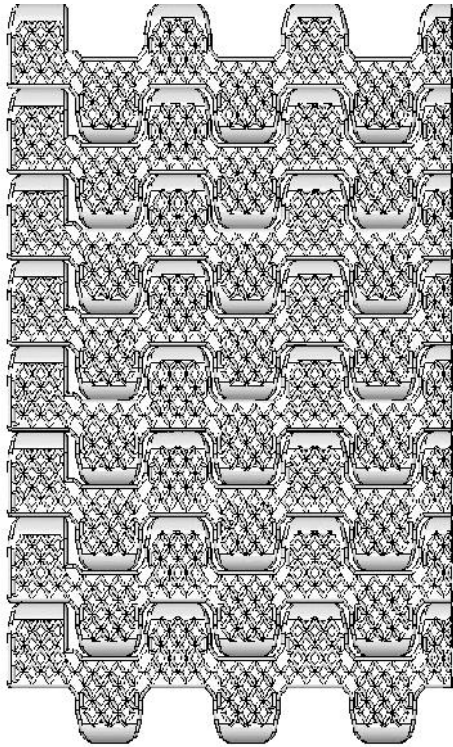

Belt data		
Materials	Max. belt pull kg/m of width	Belt weight kg/m ²
Polyethylene (PE)	600	4,5
Polypropylene (PP)	800	4,5
Polyacetal (POM)	1450	6

Belt surface: Closed top with an inverted diamond pattern
Open area: Closed.
Strength: Ideal choice for light transportation.
Material/colour: PE/nat and PP/white
Cleanability: Excellent. FSIS
Accessories: 25 mm flights, friction top.
Application: Proofing belt for raw dough. The inverted diamond pattern ensures easy product release.
 Runs on 14 mm nose bar
Standard widths: Increments of 20 mm, e.g. 100, 120 mm etc

Protected by the EU Design Registration

Sprocket Data								
No. of teeth	A= Outside diameter	B= Pitch diameter	C= Inside-diameter	Hub width:	Round bore		Square bore	
					mm	in.	mm	in.
10	50	42	33	8	20	3/4	25/40	1½
19	84	76	67	12	20/25/30/40		25/40	1½
24	104	96	87	12	20/25/30/40		25/40	1½
28	120	112	103	12	20/25/30/40		25/40	1½

